

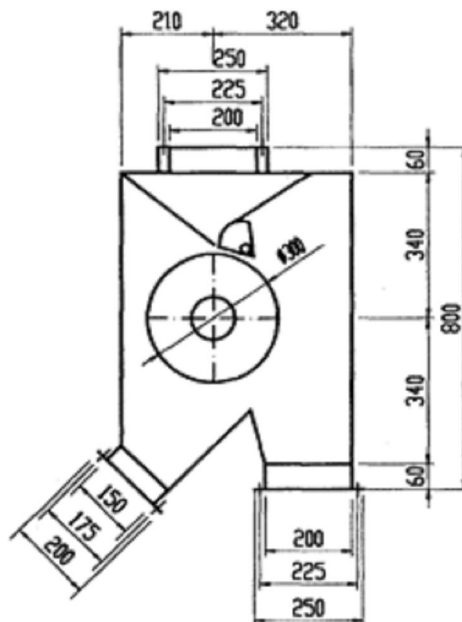

TAMBURO MAGNETICO IN CONDOTTA TM1 30-80

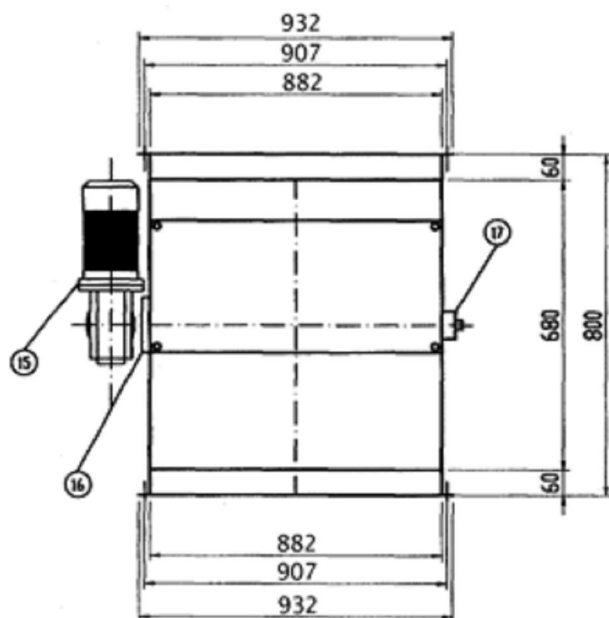

FLANGIA SUPERIORE E INFERIORE

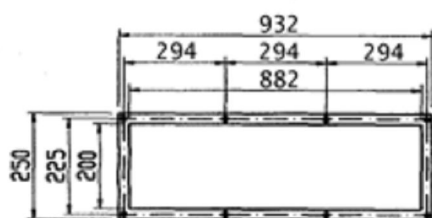

FLANGIA SCARICO FERRO

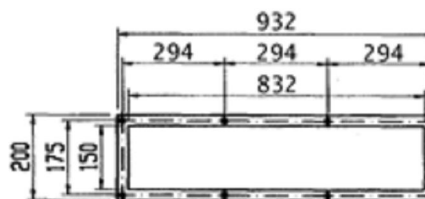

TAMBURO MAGNETICO TM30-60ND

